

**NEW
PRODUCT!**

**SD09/12 Positive multi-purpose milling insert
with 4 cutting edges**

Suitable for face milling, high feed milling and chamfer milling



Product Introduction

Achteck has upgraded the multi-purpose milling insert SD09/12 series. The insert is with positive geometry for lower cutting force, and 4 cutting edges. The pressed insert is very cost-effective. There are different coupling types, including arbor, screw head clamping, cylindrical shank, Weldon shank. It can be used in face milling, high feed milling and chamfer milling. Multiple grades can be used in steel, stainless steel, cast iron and heat resistant alloy milling.

SD09/12 Insert Introduction

- Geometry: MM4 (general purpose), MR2 (reinforced)
- Positive insert with 4 cutting edges, low cutting force
- Pressed insert with highly economical
- Insert size: 09 and 12
- Various corner radius: R0.8, R2.0, R2.5
- Various Grades: AP251U, AP403M, AP351M, AP251K, AC151K, AP403S

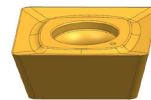

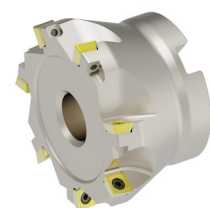
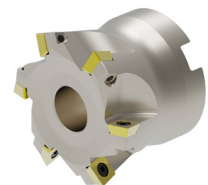

AFM89/AHM15/ACM45-SD09/12 Cutter Introduction

- Cutter Type: AFM89 (face milling), AHM15 (high feed milling), ACM45 (chamfer milling)
- Cutter Coupling: arbor, screw head clamping, cylindrical shank, weldon shank
- Approach angle (Kr): face milling 89.5°, high feed milling 15°, chamfer milling 45°
- All cutters have external coolant design, more economical
- Screw: Torx Plus 10, 15
- Nickel plated cutter surface offers good wear-resistance and corrosion-resistance
- Wide product range covers various machining conditions
 Face milling cutter diameter: $\phi 25-125\text{mm}$
 High feed cutter diameter : $\phi 25-125\text{mm}$
 Chamfer milling cutter diameter : $\phi 12-32\text{mm}$







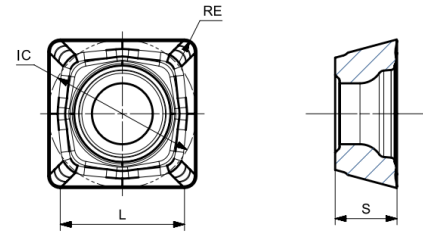

Geometry Introduction

Geometry	Cutting edge shape	Application
MM4 (General purpose)		For medium machining conditions Universal geometry For machining most materials
MR2 (Reinforced)		For medium or rough machining condition Universal geometry For machining most materials



SD09/12 Inserts



Insert	Product code	Dimension (mm)				P		M		K		S
		L	IC	S	RE	AP251U	AP351U	AP351M	AP403M	AC151K	AP251K	AP403S
	SDMT 09T308N-MM4	7.985	9.525	3.97	0.8	●		●	●	●	●	
	SDMT 09T320N-MM4 ▲	5.525	9.525	3.97	2.0	●		●	●	●	●	●
	SDMT 120408N-MM4	11.100	12.7	4.76	0.8	●		●	●	●	●	
	SDMT 120425N-MM4	7.700	12.7	4.76	2.5	●		●	●	●	●	
	SDMT 09T308N-MR2 ▲	7.971	9.525	3.97	0.8	●		●	●	●	●	
	SDMT 09T320N-MR2	5.511	9.525	3.97	2.0	●		●	●	●	●	
	SDMT 120408N-MR2 ▲	11.100	12.7	4.76	0.8	●		●	●	●	●	

● Stocked

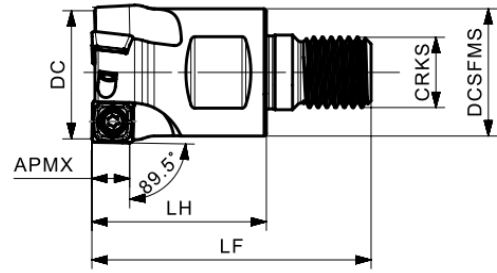

▲ 1st batch of products

● AFM89-SD09/12 Cutters



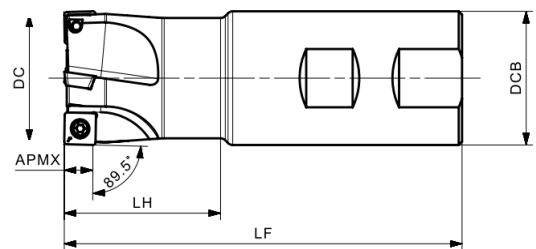
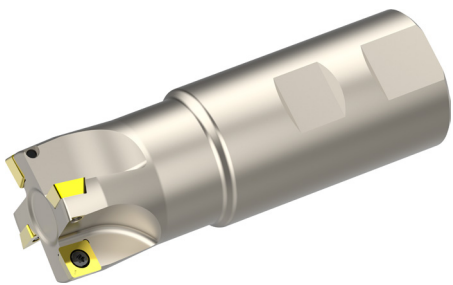





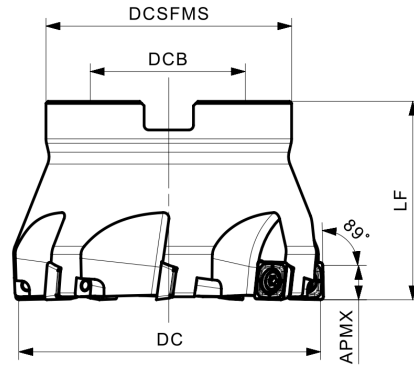
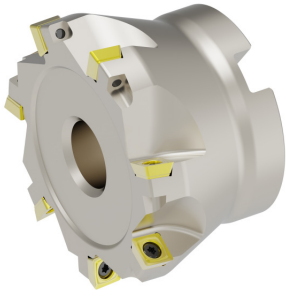



Product code	DC	CRKS	DCSFMS	LF	LH	APMX	Internal coolant	Z	Insert
AFM89-025-Z02-M12R-SD09	25	M12	23	57	35	8.6		2	SDMT 09T308N.. SDMT 09T320N..
AFM89-032-Z02-M16R-SD09	32	M16	29	64	40	8.6		2	
AFM89-032-Z03-M16R-SD09	32	M16	29	64	40	8.6		3	







Product code	DC	DCB	LF	LH	APMX	Internal coolant	Z	Insert
AFM89-025-Z02-W25R-SD09	25	25	100	44	8.6		2	SDMT 09T308N.. SDMT 09T320N..
AFM89-032-Z03-W32R-SD09	32	32	110	51	8.6		3	
AFM89-040-Z04-W40R-SD09	40	40	120	50	8.6		4	

AFM89-SD09/12 Cutters

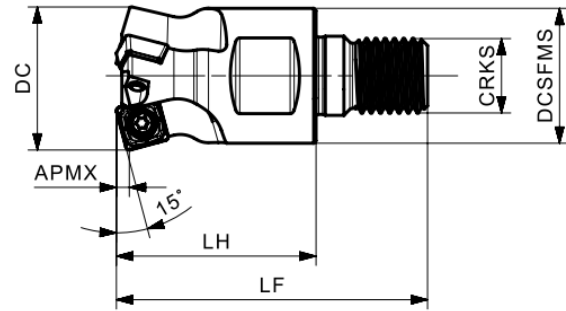

Product code	DC	DCB	DCSFMS	LF	APMX	Internal coolant	Z	Insert
AFM89-040-Z04-A16R-SD09	40	16	35	40	8.6		4	SDMT 09T308N.. SDMT 09T320N..
AFM89-050-Z05-A22R-SD09	50	22	45	40	8.6		5	
AFM89-063-Z06-A22R-SD09	63	22	48	40	8.6		6	
AFM89-080-Z07-A27R-SD09	80	27	62	40	8.6		7	
AFM89-050-Z04-A22R-SD12	50	22	45	40	11.7		4	SDMT 120408N.. SDMT 120425N..
AFM89-063-Z05-A22R-SD12	63	22	45	40	11.7		5	
AFM89-080-Z07-A27R-SD12	80	27	62	50	11.7		7	
AFM89-100-Z08-A32R-SD12	100	32	80	50	11.7		8	
AFM89-125-Z09-A40R-SD12	125	40	87	63	11.7		9	
AFM89-125-Z10-A40R-SD12	125	40	87	63	11.7		10	

• AHM15-SD09/12 Cutters



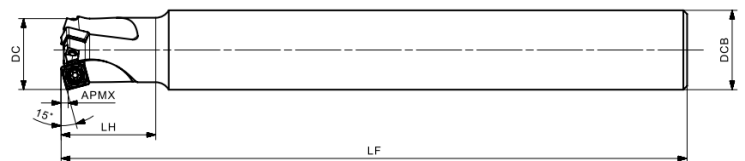





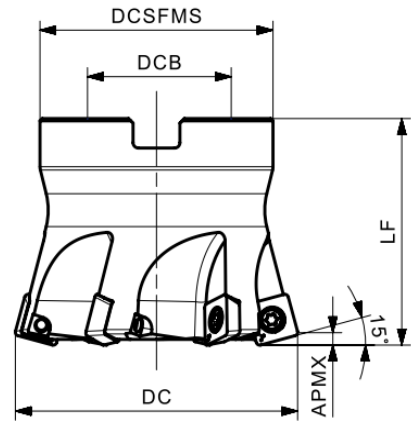
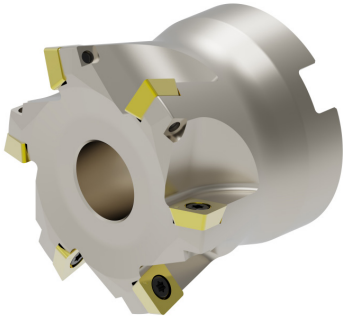



Product code	DC	CRKS	DCSFMS	LH	APMX	Internal coolant	Z	Insert
AHM15-025-Z02-M12R-SD09	25	M12	23	35	1.5		2	SDMT 09T308N.. SDMT 09T320N..
AHM15-026-Z02-M12R-SD09	26	M12	23	35	1.5		2	
AHM15-032-Z03-M16R-SD09	32	M16	29	43	1.5		3	
AHM15-033-Z03-M16R-SD09	33	M16	29	43	1.5		3	



Product code	DC	DCB	LF	LH	APMX	Internal coolant	Z	Insert
AHM15-025-Z02-C25R-SD09-L200	25	25	200	30	1.5		2	SDMT 09T308N.. SDMT 09T320N..
AHM15-032-Z03-C32R-SD09-L250	32	32	250	43	1.5		3	

AHM15-SD09/12 Cutters

Product code	DC	DCB	DCSFMS	LF	APMX	Internal coolant	Z	Insert
AHM15-040-Z03-A16R-SD09	40	16	35	40	1.5		3	SDMT 09T308N.. SDMT 09T320N..
AHM15-042-Z04-A16R-SD09	42	16	35	40	1.5		4	
AHM15-050-Z05-A22R-SD09	50	22	45	40	1.5		5	
AHM15-052-Z05-A22R-SD09	52	22	45	40	1.5		5	
AHM15-063-Z06-A22R-SD09	63	22	52	50	1.5		6	
AHM15-050-Z04-A22R-SD12	50	22	45	40	2.0		4	
AHM15-052-Z04-A22R-SD12	52	22	45	40	2.0		4	
AHM15-063-Z05-A22R-SD12	63	22	48	50	2.0		5	
AHM15-080-Z06-A27R-SD12	80	27	62	50	2.0		6	
AHM15-100-Z07-A32R-SD12	100	32	80	50	2.0		7	
AHM15-125-Z08-A40R-SD12	125	40	87	63	2.0		8	

AHM15-SD09/12 Cutters

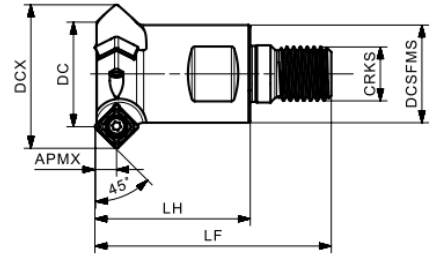

Product code	DC	DCX	CRKS	DCSFMS	LF	LH	APMX	Internal coolant	Z	Inserts
ACM45-016-Z02-M08R-SD09	16	28	M08	15	42	25	5.5		2	SDMT 09T308N.. SDMT 09T320N..
ACM45-020-Z02-M10R-SD09	20	32	M10	18	52	32	5.5		2	
ACM45-025-Z03-M12R-SD09	25	37	M12	23	59	37	5.5		3	
ACM45-032-Z03-M16R-SD09	32	44	M16	29	70	46	5.5		3	
ACM45-025-Z02-M12R-SD12	25	41	M12	23	59	37	7.5		2	SDMT 120408N.. SDMT 120425N..
ACM45-032-Z03-M16R-SD12	32	48	M16	29	70	46	7.5		3	

ACM45-SD09/12 Cutters

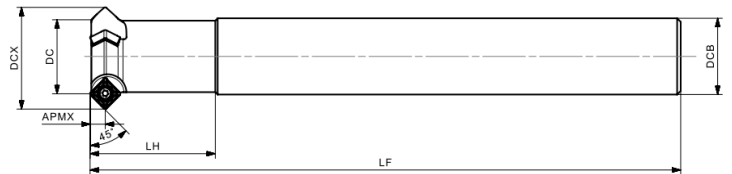

Product code	DC	DCX	DCB	LF	LH	APMX	Internal coolant	Z	Inserts
ACM45-012-Z01-C16R-SD09-L160	12	24	16	160	25	5.5		1	SDMT 09T308N.. SDMT 09T320N..
ACM45-016-Z02-C16R-SD09-L160	16	28	16	160	30	5.5		2	
ACM45-020-Z02-C20R-SD09-L180	20	32	20	180	35	5.5		2	
ACM45-025-Z03-C25R-SD09-L200	25	37	25	200	42	5.5		3	
ACM45-032-Z03-C32R-SD09-L250	32	44	32	250	53	5.5		3	
ACM45-025-Z02-C25R-SD12-L200	25	41	25	200	30	7.5		2	SDMT 120408N.. SDMT 120425N..
ACM45-032-Z03-C32R-SD12-L250	32	48	32	250	43	7.5		3	

- **Success Story**

Workpiece: Turbo charger housing

Material: 1.4848

Cutter: AFM89-032-Z03-W32R-SD09-C

Insert: SDMT 09T308N-MR2

Grade: AP403M

Operation: Plunging



Cutting		
Parameter:	Existing	Achteck
Vc [m/min]	100	100
fz [mm]	0.12	0.12
ap [mm]	2	2
Coolant	Emulsion	Emulsion
Tool life	28	35

Tool life (pcs)

